

Last Name: _____ First Name _____ Network-ID _____

Discussion Section: _____ Discussion TA Name: _____

Turn off your cell phone and put it out of sight.

Keep your calculator on your own desk. Calculators cannot be shared.

This is a closed book exam. You have ninety (90) minutes to complete it.

1. Use a #2 pencil. Do not use a mechanical pencil or pen. Darken each circle completely, but stay within the boundary. If you decide to change an answer, erase vigorously; the scanner sometimes registers incompletely erased marks as intended answers; this can adversely affect your grade. Light marks or marks extending outside the circle may be read improperly by the scanner. Be especially careful that your mark covers the **center** of its circle.
2. You may find the version of **this Exam Booklet at the top of page 2**. Mark the version circle in the TEST FORM box near the bottom of your answer sheet. **DO THIS NOW!**
3. Print your **NETWORK ID** in the designated spaces at the *right* side of the answer sheet, starting in the left most column, then **mark the corresponding circle** below each character. If there is a letter "o" in your NetID, be sure to mark the "o" circle and not the circle for the digit zero. If and only if there is a hyphen "-" in your NetID, mark the hyphen circle at the bottom of the column. When you have finished marking the circles corresponding to your NetID, check particularly that you have not marked two circles in any one of the columns.
4. Print **YOUR LAST NAME** in the designated spaces at the *left* side of the answer sheet, then mark the corresponding circle below each letter. Do the same for your **FIRST NAME INITIAL**.
5. Print your UIN# in the STUDENT NUMBER designated spaces and mark the corresponding circles. You need not write in or mark the circles in the SECTION box.
6. Sign your name (**DO NOT PRINT**) on the **STUDENT SIGNATURE line**.
7. On the **SECTION line**, print your **DISCUSSION SECTION**. You need not fill in the COURSE or INSTRUCTOR lines.

*Before starting work, check to make sure that your test booklet is complete. You should have 15 **numbered pages** plus three (3) Formula Sheets.*

Academic Integrity—Giving assistance to or receiving assistance from another student or using unauthorized materials during a University Examination can be grounds for disciplinary action, up to and including dismissal from the University.

This Exam Booklet is Version A. Mark the **A** circle in the **TEST FORM** box near the middle of your answer sheet. **DO THIS NOW!**

Exam Grading Policy—

The exam is worth a total of **116** points, composed of three types of questions.

MC5: *multiple-choice-five-answer questions, each worth 6 points.*

Partial credit will be granted as follows.

- (a) If you mark only one answer and it is the correct answer, you earn **6** points.
- (b) If you mark *two* answers, one of which is the correct answer, you earn **3** points.
- (c) If you mark *three* answers, one of which is the correct answer, you earn **2** points.
- (d) If you mark no answers, or more than *three*, you earn **0** points.

MC3: *multiple-choice-three-answer questions, each worth 3 points.*

No partial credit.

- (a) If you mark only one answer and it is the correct answer, you earn **3** points.
- (b) If you mark a wrong answer or no answers, you earn **0** points.

MC2: *multiple-choice-two-answer questions, each worth 2 points.*

No partial credit.

- (a) If you mark only one answer and it is the correct answer, you earn **2** points.
- (b) If you mark the wrong answer or neither answer, you earn **0** points.

Some helpful information:

- A reminder about prefixes: p (pico) = 10^{-12} ; n (nano) = 10^{-9} ; μ (micro) = 10^{-6} ; m (milli) = 10^{-3} ; k (kilo) = 10^{+3} ; M or Meg (mega) = 10^{+6} ; G or Gig (giga) = 10^{+9} .

The next two questions pertain to the following situation.

An object (black arrow) is located in front of a *convex* spherical mirror of radius $R = 35$ cm, as shown in the figure below. The tip of the arrow is located at $(x_o, y_o) = (16 \text{ cm}, -6 \text{ cm})$ from the mirror.

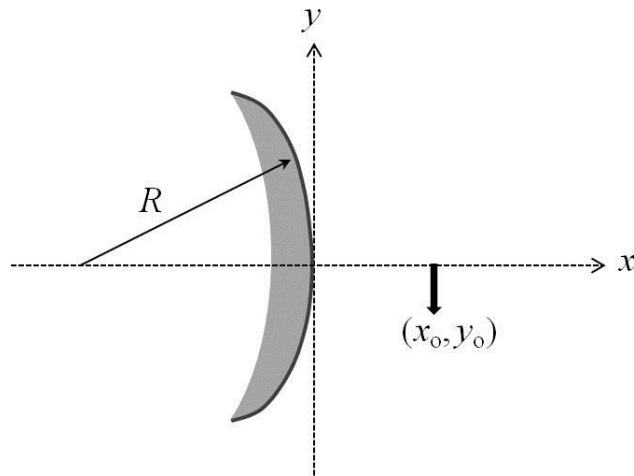

1. What is x_i , the x -coordinate of the image of the tip of the arrow?
 - a. $x_i = -8.4 \text{ cm}$
 - b. $x_i = -11.0 \text{ cm}$
 - c. $x_i = +18.7 \text{ cm}$

2. The object arrow is now moved such that the *image* distance doubles. What is $y_{i,\text{new}}$, the new y -coordinate of the image of the tip of the arrow?
 - a. $y_{i,\text{new}} = -3.13 \text{ cm}$
 - b. $y_{i,\text{new}} = +0.16 \text{ cm}$
 - c. $y_{i,\text{new}} = -0.27 \text{ cm}$
 - d. $y_{i,\text{new}} = +6.35 \text{ cm}$
 - e. $y_{i,\text{new}} = -12.7 \text{ cm}$

A laser emits light along the z axis with intensity I_0 and *unknown* polarization. To measure the polarization, you place a linear polarizer in front of the light. As shown in the figure below, when the polarizer transmission axis is vertical (along the y axis) you measure the intensity of the transmitted light to be $I_0/2$. When it is tilted 15° from vertical, you measure an intensity of $I_0/4$.

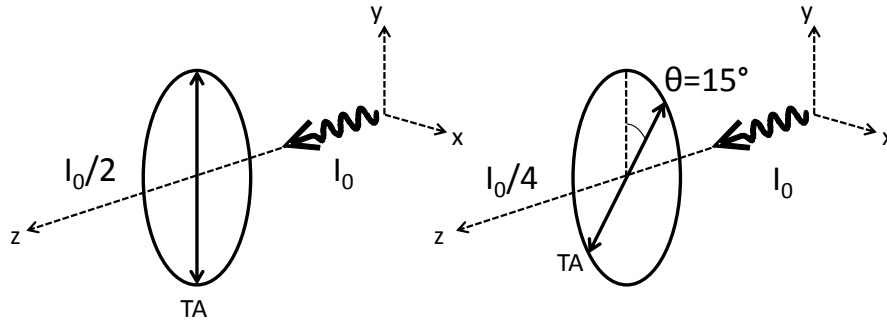

3. Which diagram of the x - y plane best represents the polarization of the laser beam?

- a.
- b.
- c.
- d.
- e.

The next three questions pertain to the following situation:

Consider the RLC circuit in the figure below. $R = 3 \Omega$, $L = 2.5 \text{ mH}$, and $C = 850 \mu\text{F}$. The circuit is driven by an AC generator with amplitude $V_{\text{max}} = 2 \text{ V}$ at a frequency $f = 60 \text{ Hz}$.

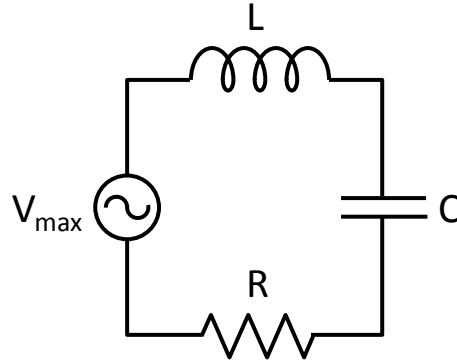

4. Calculate the amplitude of the current I_{max} through the circuit
 - a. $I_{\text{max}} = 4.6 \text{ mA}$
 - b. $I_{\text{max}} = 540 \text{ mA}$
 - c. $I_{\text{max}} = 25 \text{ mA}$
 - d. $I_{\text{max}} = 39 \text{ mA}$
 - e. $I_{\text{max}} = 127 \text{ mA}$

5. The generator voltage
 - a. leads the current
 - b. is in phase with the current
 - c. lags the current

6. Suppose the AC generator frequency f can be changed. At which frequency f is the current amplitude I_{max} in the circuit *maximized*?
 - a. $f = 0 \text{ Hz}$
 - b. $f = 60 \text{ Hz}$
 - c. $f = 109 \text{ Hz}$
 - d. $f = 1730 \text{ Hz}$
 - e. $f = 2.33 \times 10^{10} \text{ Hz}$

The next two questions pertain to the following situation.

A light ray travels through three media of known refractive indices as shown in the figure below.

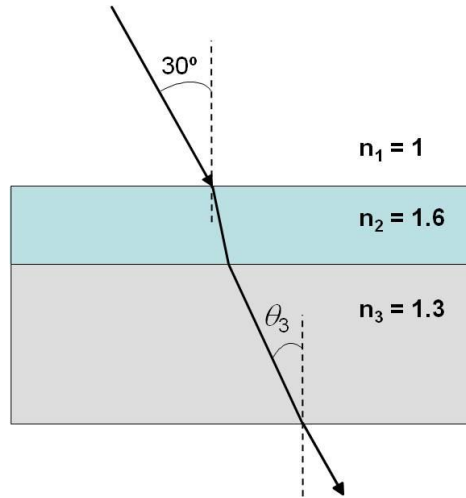

7. If the angle of incidence in medium 1 is 30° , what is the angle θ_3 (with respect to the surface normal) of the light inside medium 3?

- a. $\theta_3 = 14.7^\circ$
- b. $\theta_3 = 18.2^\circ$
- c. $\theta_3 = 22.6^\circ$
- d. $\theta_3 = 24.0^\circ$
- e. $\theta_3 = 30.0^\circ$

8. How do the *frequencies* of the light in the three media, f_i ($i = 1, 2, 3$), compare to each other?

- a. $f_1 < f_3 < f_2$
- b. $f_1 = f_3 = f_2$
- c. $f_1 > f_3 > f_2$

The next three questions pertain to the following situation:

Consider the figure below which shows a snapshot of an electromagnetic wave propagating in vacuum along the x axis. The wave is linearly polarized along the y axis and oscillates at a frequency $f = 1.25 \times 10^{12}$ Hz. The light has an average intensity $I = 0.5$ W/m².

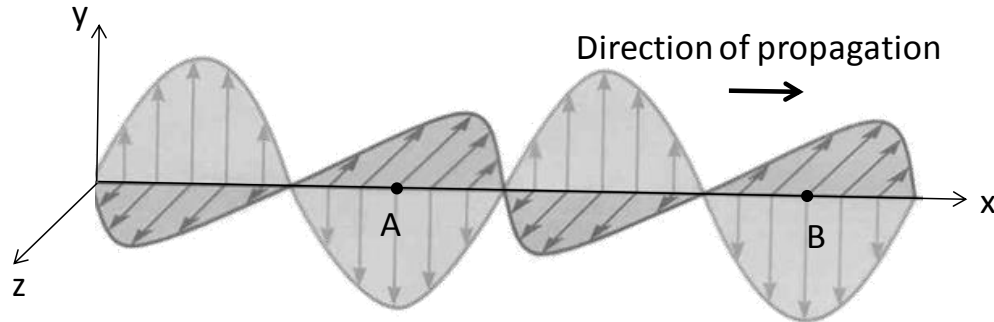

9. What is the magnitude of the electric field E at point A on the x axis at the instant shown?

- a. $E = 0$ N/C
- b. $E = 7.9$ N/C
- c. $E = 19.4$ N/C

10. Along which direction does the magnetic field oscillate?

- a. x axis
- b. y axis
- c. z axis

11. What is the distance between points A and B?

- a. 2.4×10^{-4} m
- b. 3.1×10^{-2} m
- c. 7.8×10^{-3} m

12. One way to make an airplane invisible to radar is to coat the plane with a layer of an antireflective molecule. When applied in a layer, it has an index of refraction $n = 1.42$. Assuming the antireflective layer is applied directly to the airplane, what is the minimum thickness of the coating needed for this to happen? Use 2.75 cm for the wavelength of radar waves.

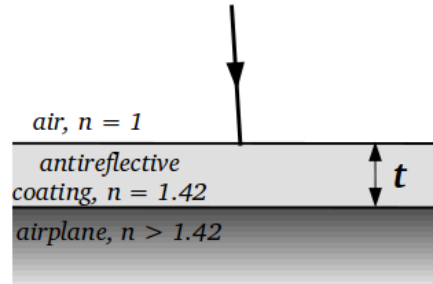

- a. $t = 2.53$ mm
- b. $t = 1.76$ mm
- c. $t = 5.93$ mm
- d. $t = 3.67$ mm
- e. $t = 4.84$ mm

13. A light ray traveling horizontally in air is incident on a prism made of glass with index of refraction $n = 1.65$ as shown in the figure below. The emerging angle from the prism is as defined in the figure.

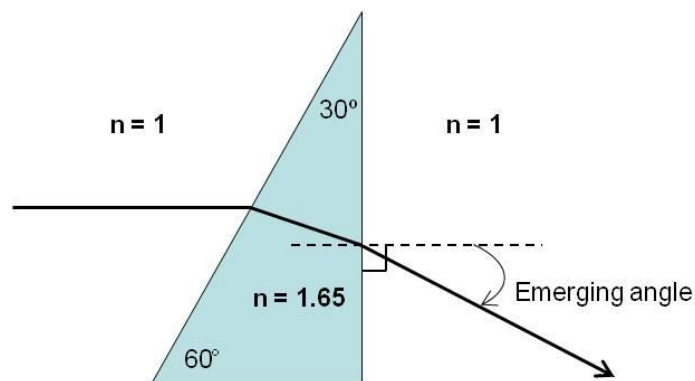

Now assume that the prism is replaced with another one of the same shape but with an index of refraction $n' = 1.55$. With respect to the original prism, the emerging angle is

- a. Larger
- b. Smaller
- c. Equal

The next two questions pertain to the following situation:

A spaceship is traveling in space just outside the earth. Its rocket engines emit light of wavelength $\lambda = 632$ nm. On earth, telescopes detect this as light of wavelength $\lambda' = 590$ nm.

14. In which direction is the spaceship moving?

- a. toward the earth
- b. away from the earth

15. How fast is the spaceship moving *relative to earth*?

- a. 2.1×10^7 m/s
- b. 3.5×10^7 m/s
- c. 6.2×10^7 m/s
- d. 1.2×10^8 m/s
- e. 6.2×10^8 m/s

The next two questions pertain to the situation described below.

A light source at the bottom of a swimming pool emits light at a wide range of angles, as shown in the figure below. The index of refraction of water is $n = 1.35$.

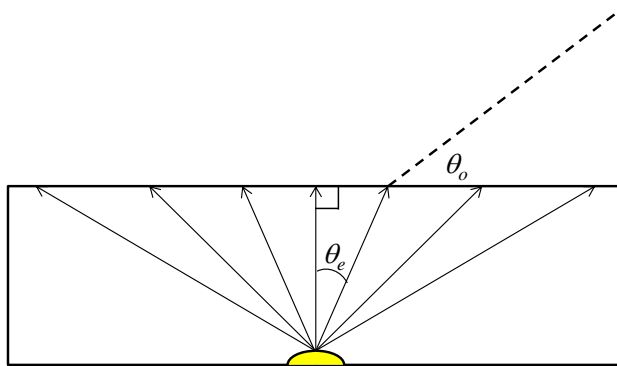

16. What is the maximum emission angle $\theta_{e,\max}$ for which light is observed above the surface (the pool is as wide as it needs to be)?

- a. $\theta_{e,\max} = 61.3^\circ$
- b. $\theta_{e,\max} = 55.1^\circ$
- c. $\theta_{e,\max} = 47.8^\circ$

17. Now consider a light ray emitted at an angle *larger* than $\theta_{e,\max}$ as shown below. After reaching the surface of water, which of the following traces would it follow?

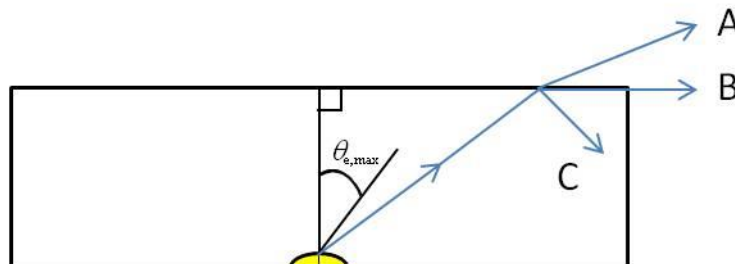

- a. Trace **A**
- b. Trace **B**
- c. Trace **C**

The following two questions refer to the figure below.

As shown in the figure below, an object (black arrow) sits in front of a diverging lens of focal length $|f| = 13$ cm, at a distance $s = 30$ cm from the lens.

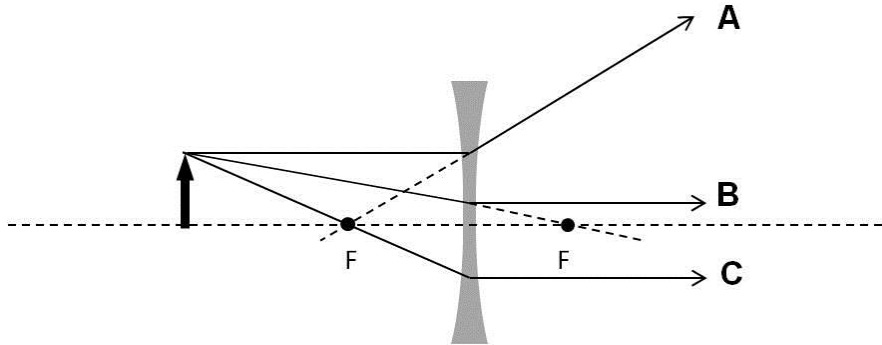

18. Which of the following rays drawn in the figure is *not* a valid principal ray?

- a. Ray **A**
- b. Ray **B**
- c. Ray **C**

19. If the object height is $h = 8$ cm, what is the height of the image, h' ?

- a. $h' = 2.4$ cm
- b. $h' = 6.1$ cm
- c. $h' = 10.3$ cm
- d. $h' = 12.5$ cm
- e. $h' = 19.2$ cm

The next three questions pertain to the situation described below.

Consider a system of two lenses as shown in the figure below. The first lens is a *diverging* lens located at $x_1 = 0$ and has a focal length of $|f_1| = 10$ cm. The second lens is a *converging* lens located at $x_2 = 40$ cm and has a focal length of $|f_2| = 14$ cm. The distance between the object (black arrow) and the first lens is $d = 18$ cm.

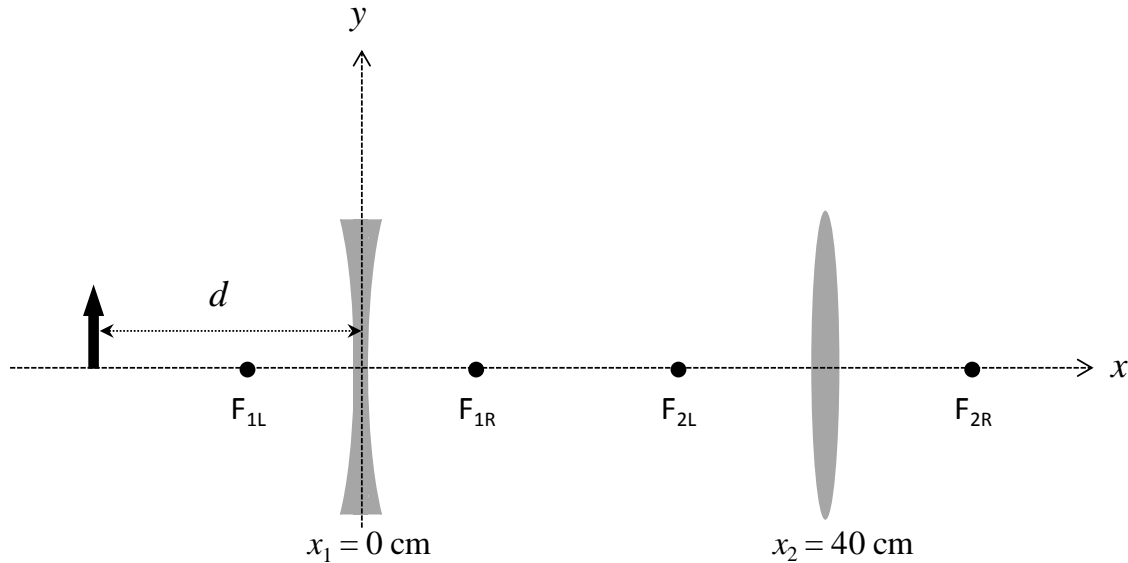

20. What is $x_{i,\text{final}}$, the x-coordinate of the final image formed by the two lenses?

- $x_{i,\text{final}} = -11.9$ cm
- $x_{i,\text{final}} = +15.7$ cm
- $x_{i,\text{final}} = +21.2$ cm
- $x_{i,\text{final}} = +24.0$ cm
- $x_{i,\text{final}} = +60.0$ cm

21. What is the nature of the final image in this system?

- Real, inverted, and reduced
- Real, upright, and enlarged
- Virtual, inverted, and enlarged
- Virtual, upright, and inverted
- Virtual, upright, and reduced

The next two questions pertain to the following situation:

The distance between the center of the lens and the retina of an extremely nearsighted person is measured to be 27 mm long. Her far point is 10 cm from the center of the lenses of her eyes.

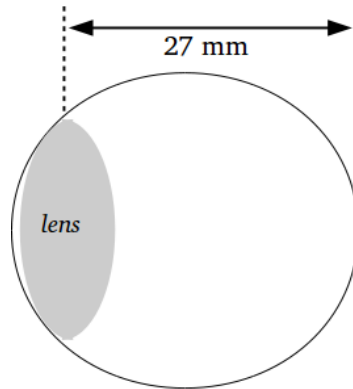

22. What is the focal length of the lens of this person's eyes?

- a. $f_{eye} = +0.1$ cm
- b. $f_{eye} = +1.3$ cm
- c. $f_{eye} = -2.7$ cm
- d. $f_{eye} = +2.1$ cm
- e. $f_{eye} = -1.0$ cm

23. What is the power P_{lens} (in diopters) of the contact lens needed to correct this person's vision to focus a book placed 25 cm from her eyes without squinting? Assume the contact lens is placed directly next to the lens of the person's eye.

- a. $P_{lens} = -6.00$ diopters
- b. $P_{lens} = -2.93$ diopters
- c. $P_{lens} = -8.46$ diopters
- d. $P_{lens} = +5.06$ diopters
- e. $P_{lens} = +3.24$ diopters

24. You are setting up a set of three front speakers for your home entertainment console. One is placed at the center and the other two symmetrically around the center, as shown in the diagram. The center of a piece of furniture is 2 meters in front of the center of the entertainment console. The sound from all of the speakers is emitted in phase with a wavelength $\lambda = 0.1$ m.

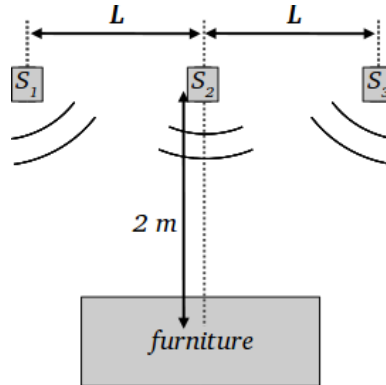

Of the following, which is the smallest distance L greater than 1.000 m that the speakers can be placed relative to the center of the console which causes maximum constructive interference at the center of the piece of furniture?

- a. $L = 1.414$ m
- b. $L = 1.136$ m
- c. $L = 1.887$ m

The next two questions pertain to the following situation:

Monochromatic light of wavelength 550 nm falls on two slits spaced 0.12 mm apart, forming fringes on a screen 0.75 m away.

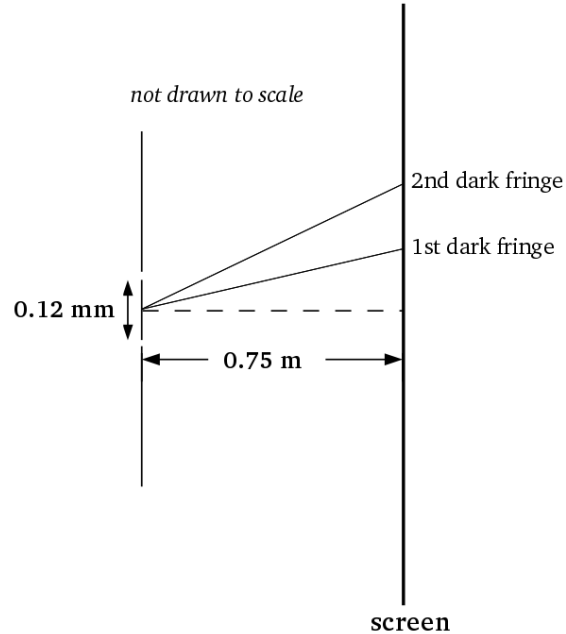

25. What is the distance, $y_2 - y_1$, between the first and second dark fringes located from the central axis? Assume the distance between the fringes on the screen is much smaller than the slit-to-screen distance (that is, $y_2 - y_1 \ll 0.75$ m).

- $y_2 - y_1 = 0.13$ mm
- $y_2 - y_1 = 3.44$ mm
- $y_2 - y_1 = 5.15$ mm
- $y_2 - y_1 = 2.29$ mm
- $y_2 - y_1 = 1.72$ mm

26. How would the distance between the first- and second-order dark fringes change if the distance between the two slits was decreased?

- $y_2 - y_1$ would increase
- $y_2 - y_1$ would not change
- $y_2 - y_1$ would decrease

**Check to make sure you bubbled in all your answers.
Did you bubble in your name, exam version and network-ID?**